

OASIS BREAK-OUT MEETING TABLE

Specifications:

- Oasis Break-Out Meeting Table Height is 730mm
- Adjustable Feet
- E0 Rated Melamine Board
- Retro Silver Frame
- 3 Year Warranty

3YEAR
warranty

Boxed Item - *Assembly Required*

Product Code: #06155
1800W x 750D

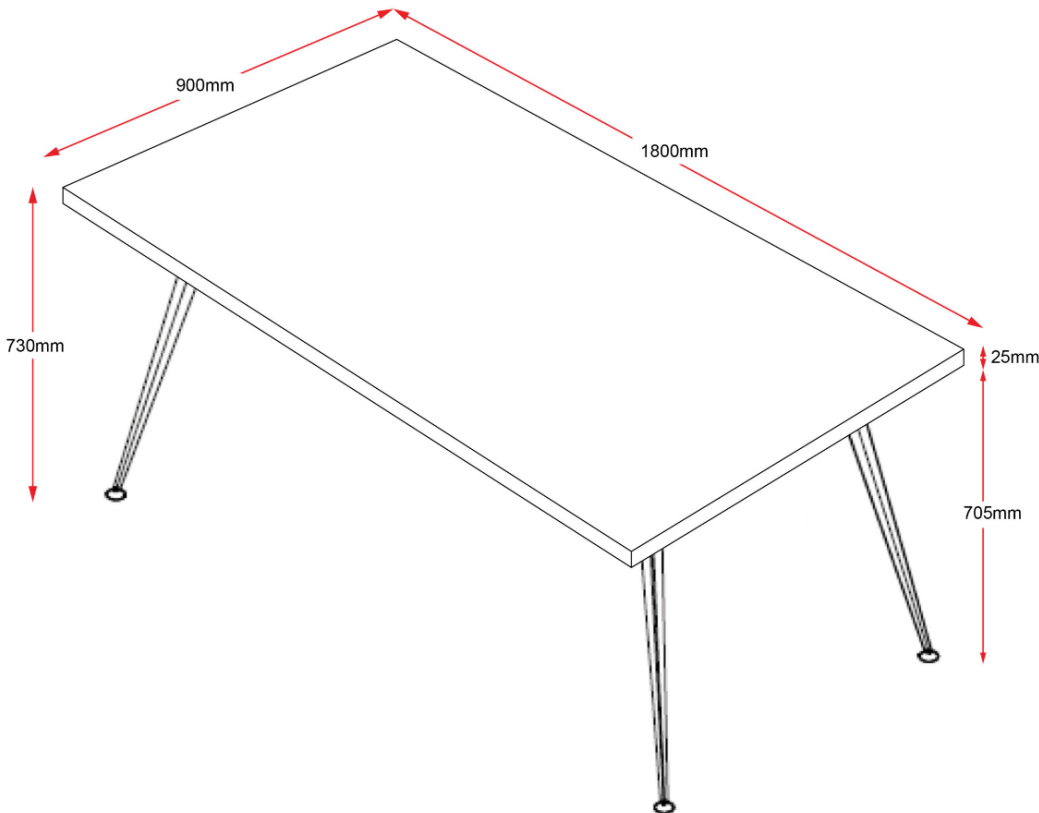
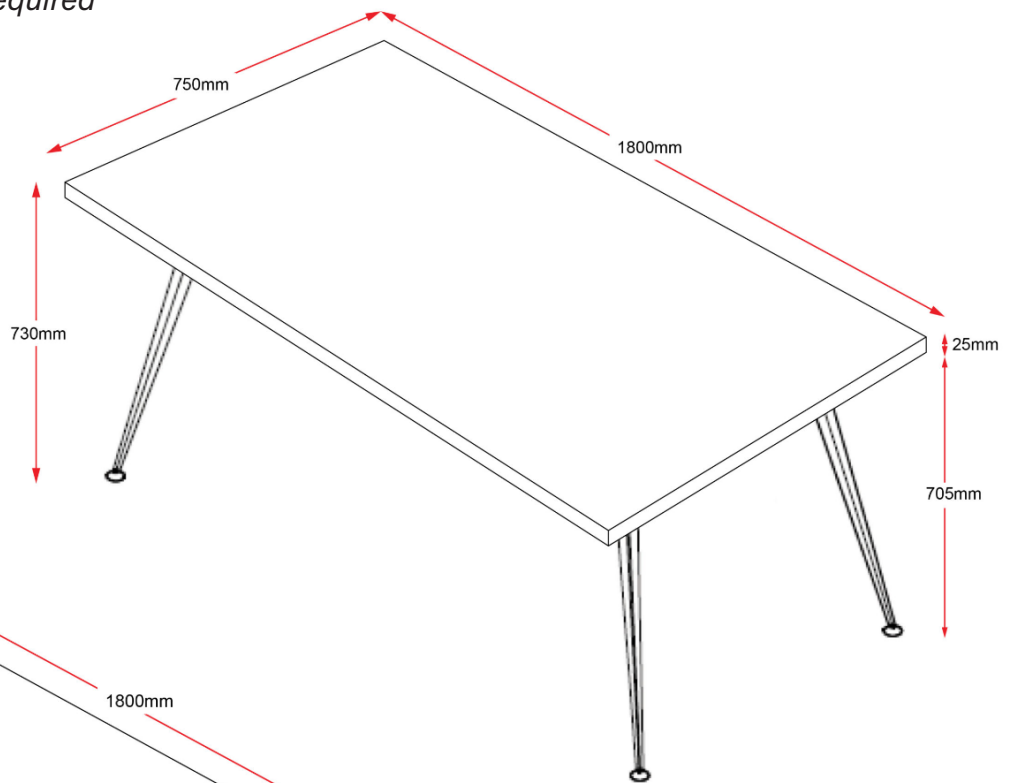

Product Code: #06156
1800W x 900D

OASIS BREAK-OUT MEETING TABLE

Assembly Instructions:

Time Required: 25minutes

Tools Required: Screwdriver, Electric Drill, Pencil, Measuring tape/Ruler

*Tools are not included

Skills required:



The Assembly Skill Rating is a 5-point system that shows the degree of effort needed in assembling a specific product. With 1 being easy for the average person and 5 requiring an expert. For most products, two persons are recommended

PLEASE NOTE





- As this is a commercial product, some intermediate skills may be required.
- Please check you have all hardware before assembling.
- Assemble on a clean, flat, smooth surface such as a rug or carpet to avoid parts from being scratched.
- Remove all wrapping materials, including staples and packing straps before you start to assemble
- Keep all hardware parts out of reach of children.

CAUTION

- Heavy product. Do not attempt to lift or move without help
- Do not tighten screws and bolts until completely assembled.
- Do not use this product unless all bolts and screws are firmly secured and tightened.

WARNING

- If parts are missing, broken, damaged or worn stop using the product until all repairs are made.
- Failure to follow these warnings could result in serious Injury

	MS*20H 32pcs		MS*1H 8pcs
	MB*20H 8pcs		1pcs

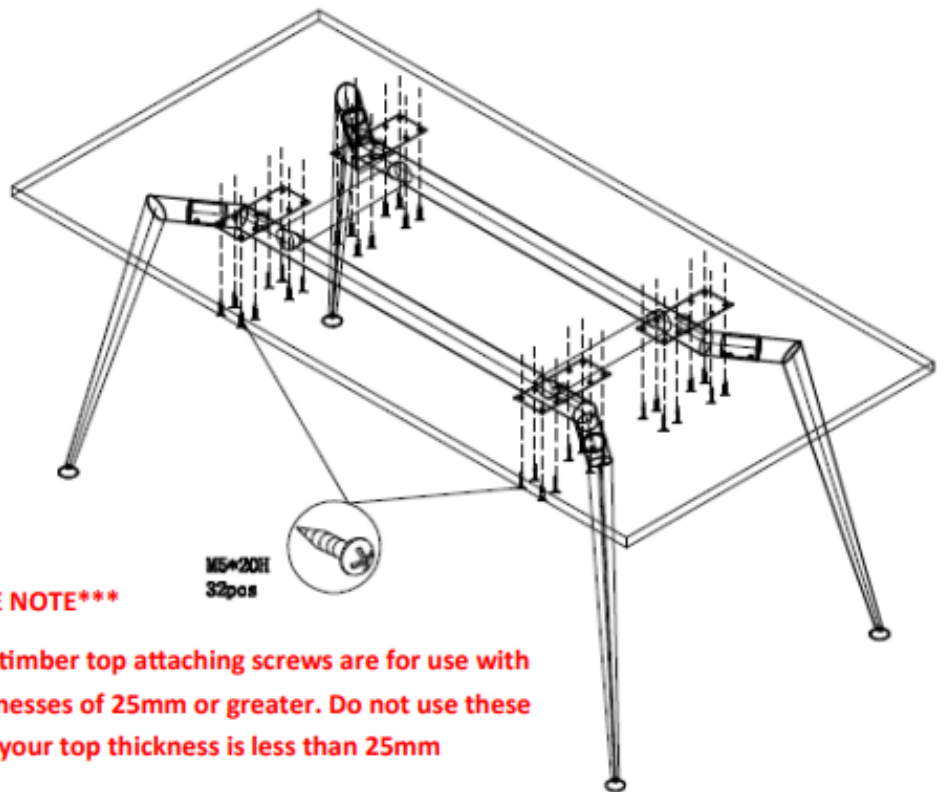
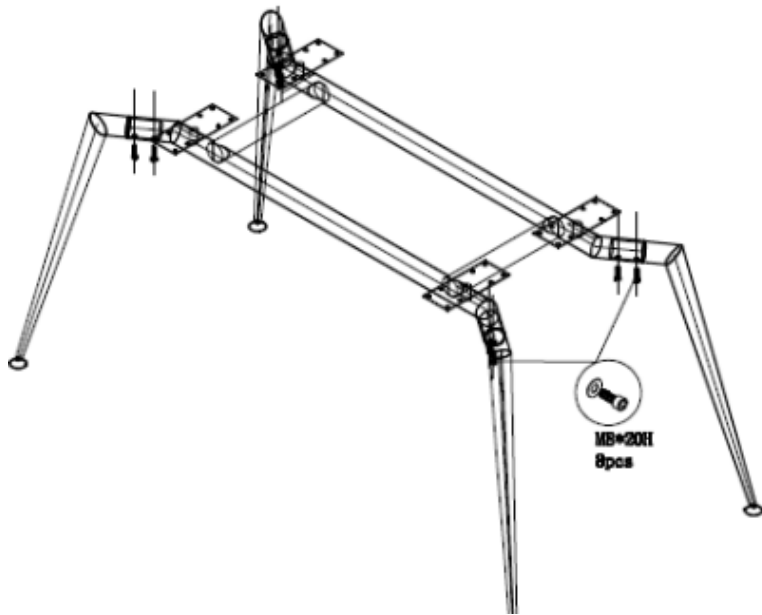

****PLEASE NOTE****

Supplied timber top attaching screws are for use with top thicknesses of 25mm or greater. Do not use these screws if your top thickness is less than 25mm